

Brookings Kitchen Cabinet Filler 96x3x0.75

Espresso

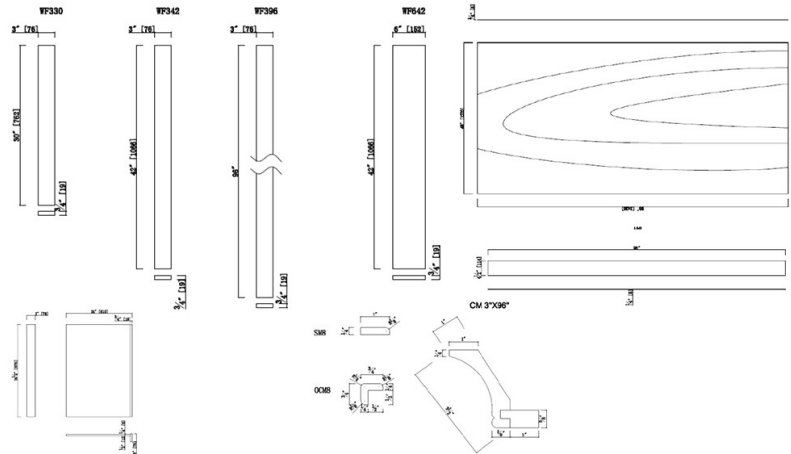

SPECIFICATIONS

MATERIAL CONSTRUCTION:	Wood	NUMBER OF SHELVES:	0
WOOD SPECIES:	Maple	SHELF STYLE:	N/A
ASSEMBLED DIMENSIONS:	3" H x 96" L x 0.75" D	ADJUSTIBLE SHELVES:	N/A
ASSEMBLED WEIGHT:	16.75 lbs.	SHELF ADJUSTIBILITY INCREMENTS:	N/A
KITCHEN CABINET TYPE:	Filler	SHELF DIMENSIONS:	N/A
MOUNTING TYPE:	N/A	SHELF THICKNESS:	N/A
CONSTRUCTION TYPE:	Face Frame	SHELF MATERIAL:	N/A
HINGE STYLE:	N/A	FACE FRAME MATERIAL:	Solid Maple
DOOR STYLE:	N/A	SIDES MATERIAL:	Plywood
DRAWER DIMENSIONS 1:	N/A	BOTTOM MATERIAL:	Plywood
DRAWER DIMENSIONS 2:	N/A	BACK PANEL MATERIAL:	Plywood
DRAWER DIMENSIONS 3:	N/A	BACK BRACE MATERIAL:	Wood
DWR BOX MATERIAL:	N/A	TOE KICK INSET WIDTH:	N/A
DWR CONSTRUCTION:	N/A	TOOLS NEEDED FOR INSTALLATION:	Phillips Screwdriver Wood Glue Mallet
DWR GLIDE:	N/A	FASTENER TYPE:	N/A
FAKE DWR QTY:	0		
FAKE DWR LOCATION:	N/A		

WARRANTY:	1-Year limited warranty
LEGAL FOR SALE IN CALIFORNIA:	Yes
CARB COMPLIANT:	N/A
TSCA TITLE IV COMPLIANT:	Yes



TYPE: JOB: ORDER CODE: APPROVALS:
--