

Design House is a registered brand of DHI Corp.

Mequon, WI 53092
1-800-558-8700

TWO HANDLE LAVATORY FAUCET

Models 522862, 522870

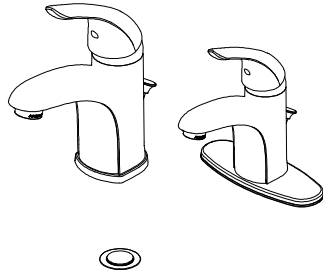

Your new Design House faucet will give you years of trouble free performance. Thank you for choosing our product for your home. **Please read all of these instructions carefully before installing your new faucet.**

Helpful tools to install this faucet:

- basin wrench
- Teflon tape
- (2) crescent wrenches
- silicon sealer
- flashlight
- faucet supply tubes

IMPORTANT POINTS

- When installing your new faucet, hand tighten the connector nuts, then use one wrench to anchor the fitting and a second wrench to tighten the nut one additional turn. Connections that are too tight will reduce the integrity of the system.
- Wrap all threaded connections (except aerator thread in spout) with Teflon tape available from your local hardware or plumbing supply store. Always wrap in a counter-clockwise direction.

SAFETY TIPS

- **ALWAYS** protect your eyes with safety glasses.

INSTALLATION PROCEDURE

1. Shut off water supplies. Remove old faucet. Flange Installation (optional) - Place flange (1A) on bottom of new faucet. Place faucet through mounting holes in sink. Secure faucet to sink using washer (1B) and nut (1C) provided.

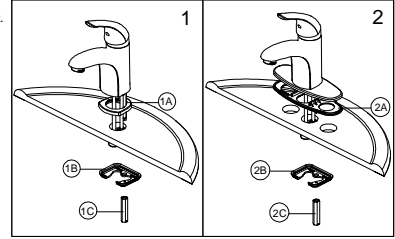

2. Escutcheon Installation (optional) - Place gasket (2A) on bottom of new faucet. Place faucet through mounting holes in sink. Secure faucet to sink using washer (2B) and nut (2C) provided.

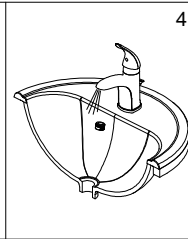
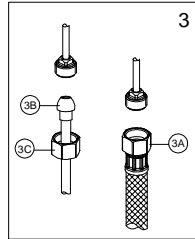
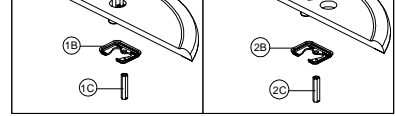

3. Make connections to water lines. Use 1/2" IPS faucet connections (3A) or use the supplied coupling nuts (3B) with 3/8" O.D. ball-nose risers (3B). Use wrenches to tighten connections. Do not overtighten.

4. Important: After installation is completed, remove aerator with plastic wrench. Turn on water supply and allow both hot and cold water to run for at least one minute each. While water is running, check for leaks. Replace aerator.

MAINTENANCE

Your new Design House faucet is designed to give you years of trouble free performance. Keep it looking new by cleaning it periodically with a soft cloth. Avoid abrasive cleaners, steel wool and harsh chemicals that will dull the finish and void your warranty.

Brass finishes are polished, then protected with a lacquer coating to help prevent tarnishing. Clean these surfaces only with a damp, soft cloth.

CONSUMER PROTECTION WARNING

Under the Safe Drinking Water Act, the U.S. Environmental Protection Agency restricts the amount of lead used in brass and solder. Your new faucet is made in strict compliance with all government standards. The materials used in the manufacture of this faucet are of industry standard quality and are similar to other plumbing products having brass fittings.

To reduce the amount of lead in your drinking water, allow the water to run for a moment before filling your glass and remember to always use cold water for drinking purposes.

TROUBLE SHOOTING

Problem: Faucet leaks from under handle.

Cause: Bonnet is loose or o-ring on cartridge is dirty or twisted.

Action:

1. Move handle to OFF position. Remove handle and unscrew the set screw on the handle connector. Then remove the handle seat.
2. Tighten the bonnet by turning it clockwise. Move the cartridge stem to the ON position. The leak should stop around the cartridge stem.
3. If the leak does not stop, shut off the water supply. Remove the bonnet by turning it counter clockwise. Lift out the cartridge valve. Inspect the o-rings. Clear debris, untwist, or replace if necessary.
4. Replace the cartridge making sure the wings fit well into the cuts in the faucet body. Tightly screw the bonnet onto the faucet body.
5. Reinstall the handle.

Problem: Faucet leaks around aerator or an improper flow pattern.

Cause: Aerator is incorrectly fitted or is dirty

Action:

1. Unscrew the aerator. Make sure all internal parts are laying flat.
2. If there is debris, gently flush all parts inside.
3. Reinstall aerator.

Many of these parts come preassembled. This exploded diagram is to assist in trouble shooting.

POP-UP INSTALLATION EXPLODED PARTS

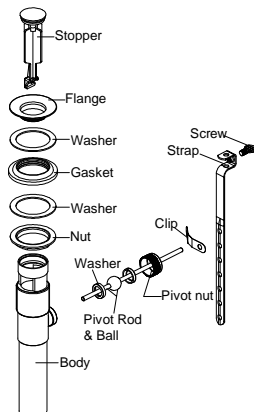
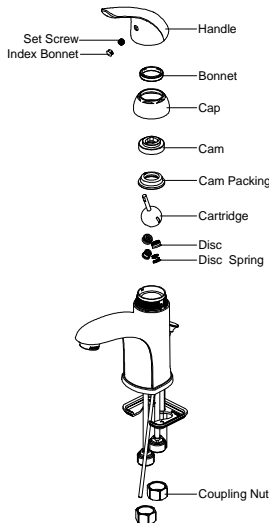

POP-UP (OPTIONAL) INSTALLATION PROCEDURE

1. Remove stopper (1) and flange (2). Screw nut (3) all the way down. Push washer (4) and gasket (5) down. Remove tailpiece (6) from body (7), add Teflon tape, replace tailpiece.

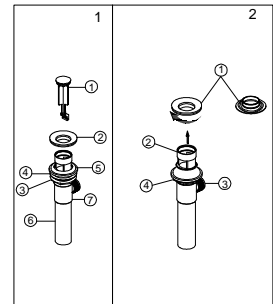

2. Apply a small bead of Plumber's putty to underside of flange (1). Insert body (2) into sink. Screw flange (1) into body (2). Pivot (3) must face faucet. Pull assembly down firmly and hold in place. DO NOT TWIST. Tighten nut, washer & gasket (4), clean off excess Plumber's putty.

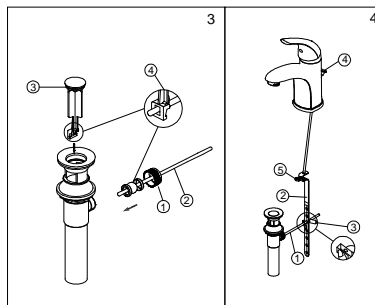

3. Remove pivot nut (1). Install horizontal rod (2) and stopper (3) as non-removable (4). Hand tighten pivot nut (1).

4. Attach horizontal rod (1) to strap (2) using clip (3). Insert lift rod (4) into strap and tighten screw (5).